

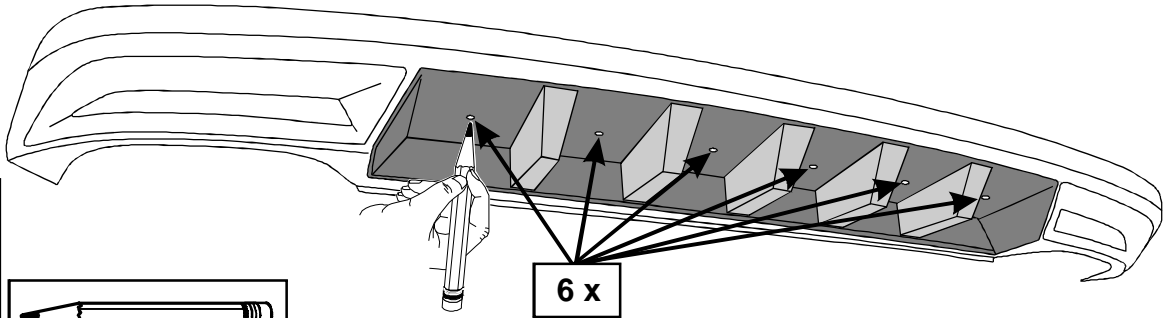

3.b

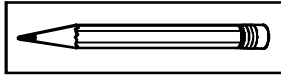

6 x

3.c

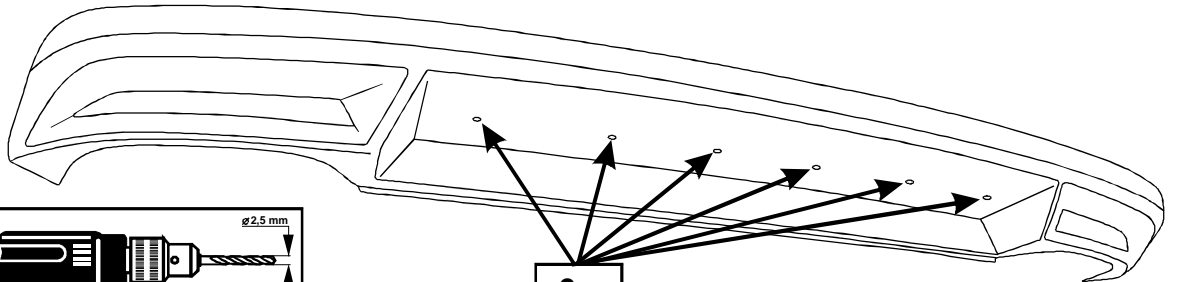
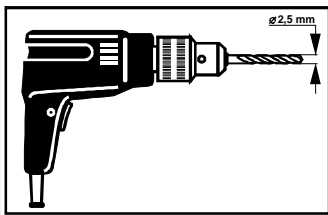

6 x

3.d

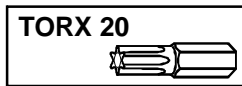
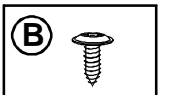

TORX 20

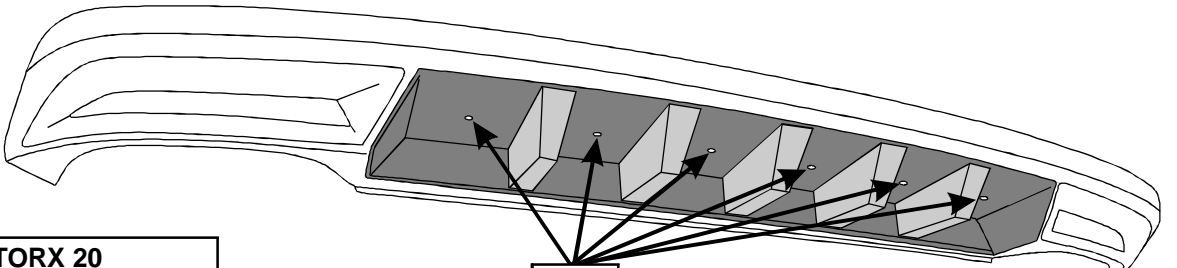

6 x

4.a

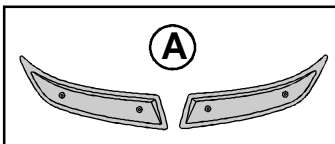

L + R

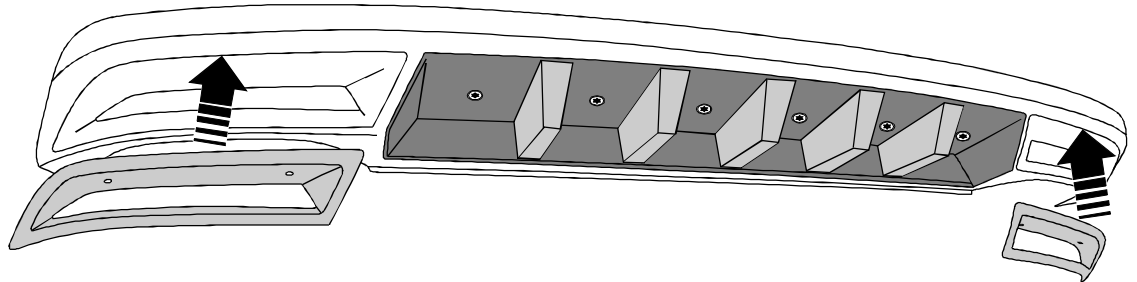

4.b

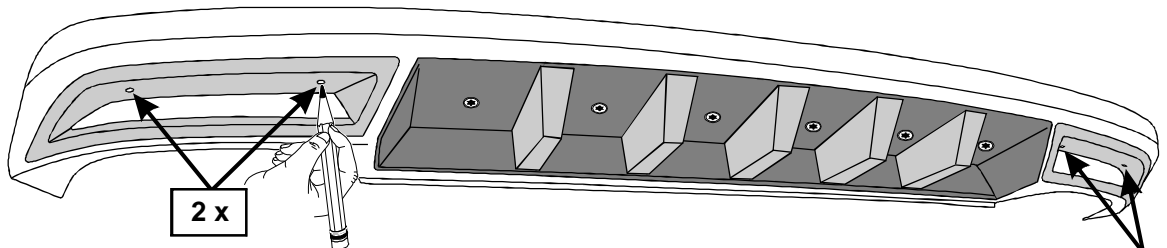

2 x

2 x

